



FMS Private Limited



Creating Spaces that Inspire

With Our Exceptional
Facilities Management



 www.aurafacilitiesmanagement.com
 +91-8655661739 | +91-9820403068

 info@aurafms.com

To View E-Catalogue
Please Scan QR Code

About Our Company

Aura FMS, founded in 2005 by two seasoned management professionals and first-generation entrepreneurs, was born out of a deep understanding of workplace dynamics and the unique needs of different industries. Drawing on their keen observations and strategic insights gained from years of experience, they embarked on this venture to redefine facilities management and provide tailored solutions that truly resonate with businesses across sectors.

Headquartered in Mumbai with a PAN-India footprint, Aura FMS has established itself as a leading provider of comprehensive Facilities Management and Security Solutions.

The company offers a wide range of integrated services, including Cleaning and Janitorial Services, Specialized Cleaning, Pest Management, Technical Services, Staffing & Payroll Management, and Security Solutions. Aura FMS caters to a broad spectrum of sectors, such as Corporate Offices, Retail, Malls, Theatres, Banking and Financial Institutions, Real Estate, Infrastructure Projects, Hospitals, Housing Societies, Hotels, Educational Institutions, Industries, and Government Enterprises.



Why Choose Aura ?

We are convinced that our success stems not just from the quality of our services but from our dedication to upholding our core values.



Quality

We are dedicated to delivering superior services that guarantee customer satisfaction and build lasting loyalty.



Innovation

By embracing creativity and advancing technology, we continually aim to stay ahead of the curve and deliver cutting-edge solutions.



Integrity

Our operations are grounded in ethical conduct and transparency, which help build and maintain strong relationships with our clients and partners.



Customer-Centric Approach

Placing our client's needs at the center of our operations, we tailor our services to not only meet but exceed their expectations.



Diversity and Inclusion

We embrace diversity and cultivate an inclusive environment that encourages collaboration, creativity, and personal growth.



Sustainability

We are dedicated to reducing our environmental impact, promoting eco-friendly practices, and actively contributing to the well-being of our communities.

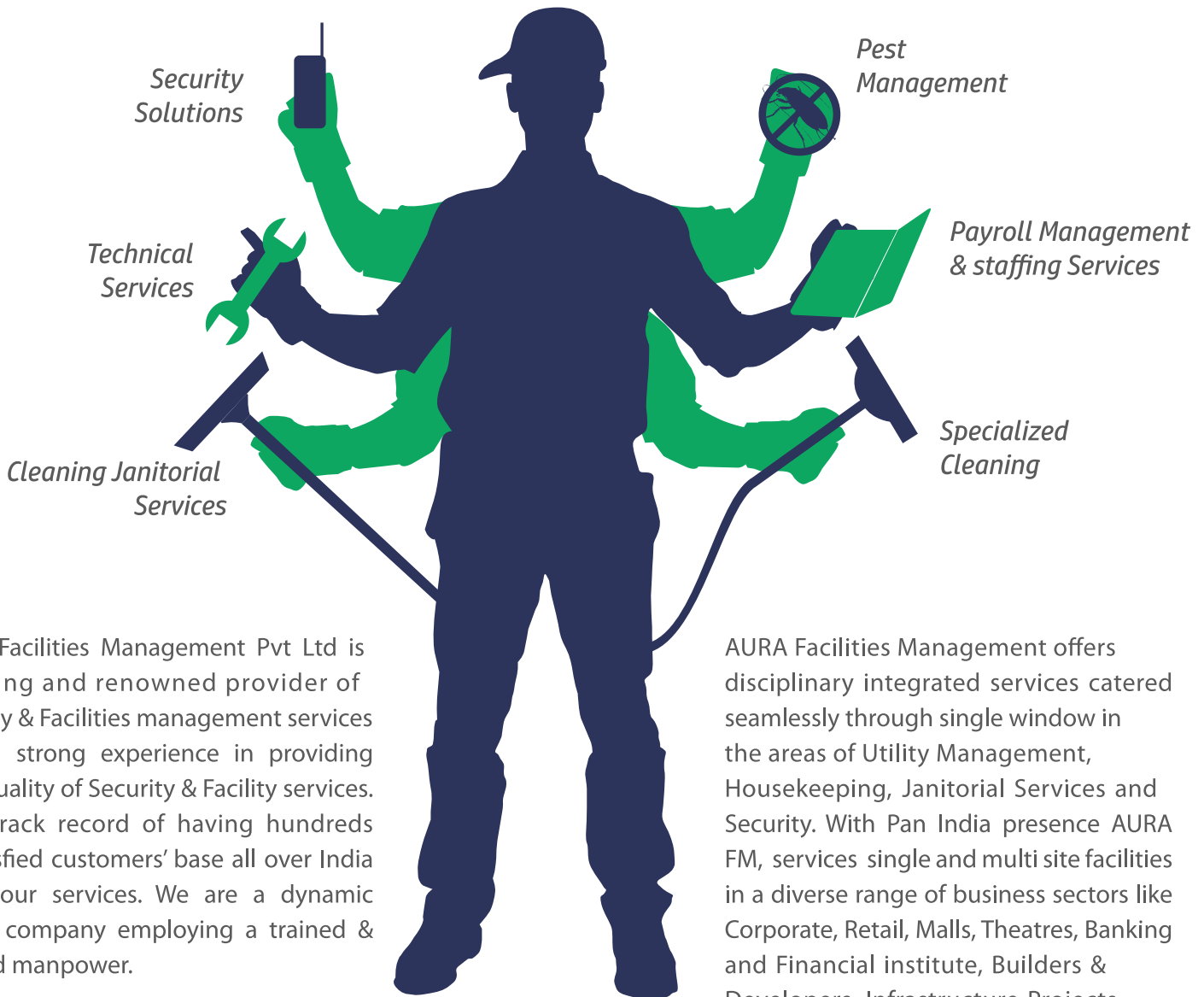

AURA Facilities Management Pvt Ltd is a leading and renowned provider of Security & Facilities management services. Having strong experience in providing high quality of Security & Facility services. With track record of having hundreds of satisfied customers' base all over India using our services. We are a dynamic driven company employing a trained & verified manpower.

AURA Facilities Management is conceived by two senior management professional and first generation entrepreneur; incepted in 2005 with head quarters in Mumbai.

AURA Facilities Management offers disciplinary integrated services catered seamlessly through single window in the areas of Utility Management, Housekeeping, Janitorial Services and Security. With Pan India presence AURA FM, services single and multi site facilities in a diverse range of business sectors like Corporate, Retail, Malls, Theatres, Banking and Financial institute, Builders & Developers, Infrastructure Projects, Hospitals, Cooperative Housing Society, Hotels, School & Colleges, Industries and government undertaking.

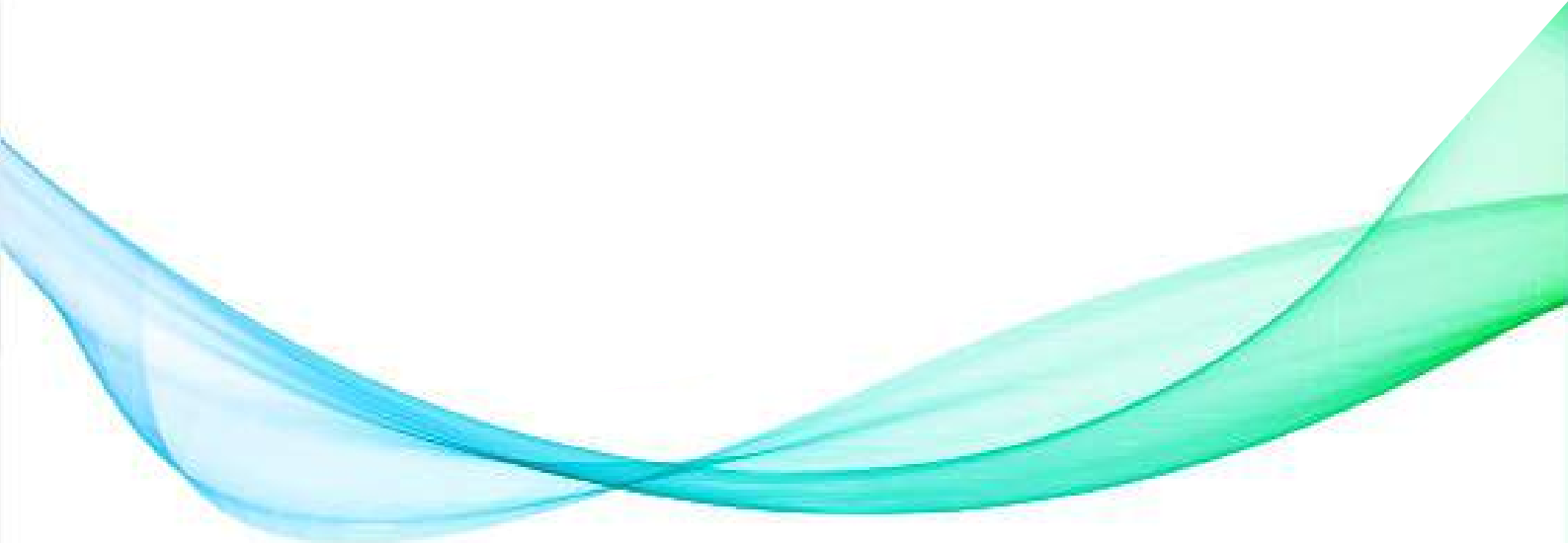



Vision:

To become the nationwide leader in facility services.
To help clients to keep their surrounding clean so they can live better.

Mission:

Our mission is to be the best Facility Management Company in India. To achieve this goal, we focus relentlessly on carrying out our business principles, which are fundamental to everything we do:

- Aspire to be the best
- Execute superbly
- Build a great team and a winning culture

Cleaning Janitorial Services:

Clean surrounding is a happier and healthier place to live and work. We provide various range of hygiene services to Clubs, Commercial Establishments, Factories, Guesthouses, Government Organizations, Hospitals, Hotels, Housing Complexes, Institutes, Malls, Multiplexes, Restaurants, and Service Apartments.

We have a highly experienced & trained team which works in close co-ordination with our clients to deliver services in exact accordance to international standard and up-to their specifications. Our intense service training programs and well trained on-site service from our supervisors and area managers creates a value added service to our customers.



Technical Services:

We provide all types of maintenance staff like Plumbers, Electrician, AC Mechanics, Carpenters, and Painters on fixed basis or on call basis.



Operations & Support (MEP)

We Understand that Every Facility Experiences Wear and Tear Over Time. at Aura FMS, we are Committed to Managing this Wear and Tear Through Regular Maintenance Checks and Prompt Resolution of any Issues that Arise.

Aura FMS Employs a Team of Skilled and Well-Trained Maintenance Professionals to Address both Expected and Unexpected Breakdowns. Our Team Includes Plumbers, Electricians of all Categories, AC Technicians, Carpenters, Painters, and More, Ensuring Comprehensive Support for Your Maintenance Needs.

At Aura FMS, we Provide Reliable and Efficient Maintenance Services. Our Expert Team Ensures that Your Plumbing, Electrical, and Mechanical Systems are Well-Maintained, Minimizing Disruptions and Maintaining the Overall Functionality of Your Facility.



Plumbing Services:



Leak Detection and Repair



Pipe Installation and Replacement



Drainage System Cleaning and Maintenance



Fixture Repairs and Installations



Water Conservation Solutions



Sewage and Septic System Services



Electrical Services:



Emergency Electrical Repair



Wiring and Rewiring



Lighting Installation and Maintenance



Electrical Safety Inspections



UPS and Backup Power Systems



Circuit Breaker Testing and Replacement

Mechanical Services:



HVAC Installation and Maintenance



Mechanical Repairs



Preventive Maintenance



Chiller and Boiler Maintenance



Ventilation and Air Filtration Services



Pumps and Motors Management



Civil Work:



Waterproofing and Damp Proofing



Drainage and Sewage Systems



Interior and Exterior Finishing



Masonry and Brickwork



Emergency and Preventive Services



Quality and Compliance

Water & Sewage Plants Filtration:



Water Filtration System Installation



Sewage Treatment Plant (STP) Setup and Maintenance



Water Quality Testing and Monitoring



Reverse Osmosis (RO) System Management



Greywater Recycling Solutions



Pump and Piping Maintenance

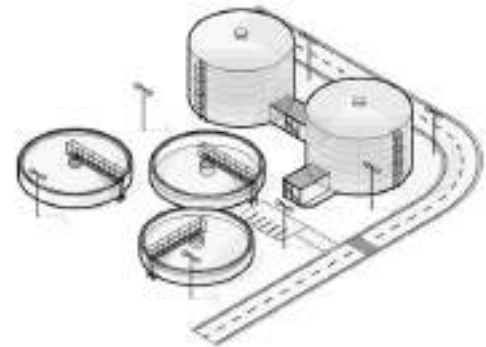

Data Centre:

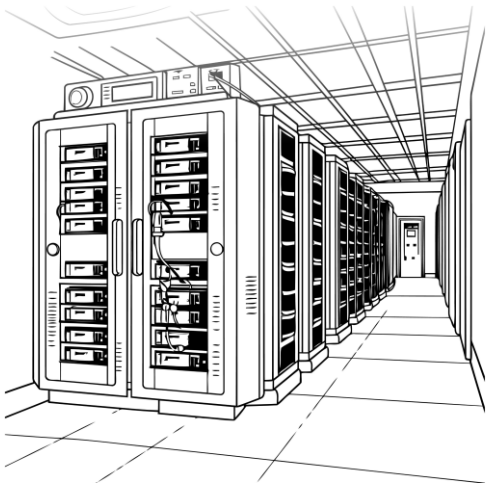

Power Management and Backup Systems



Critical Environment Management



Security and Access Control



Network Cabling and Connectivity



Preventive Maintenance and Equipment Servicing



Support and Incident Management

Fire Protection & Preventive Systems:



Comprehensive Risk Assessment



Fire Detection & Alarm Systems



Fire Suppression Systems



Regular Inspections & Compliance Checks



Smoke Control & Ventilation Systems



Emergency Response Planning & Drills



Refurbishments & Interior Renovations:



Space Optimization & Layout Planning



Sustainable Materials & Practices



Electrical & Plumbing Upgrades



Modular & Flexible Design



Smart Technology Integration



Quality Control & Inspections



CCTV Services & Installations:



Comprehensive Site Assessment



High-Resolution Cameras



Remote Monitoring & Access



Data Storage & Management



Cybersecurity for CCTV Systems



User Training & Support



Energy Conservation Checks

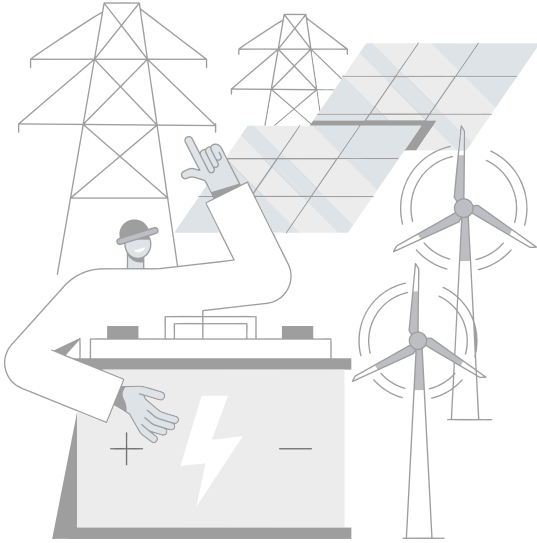

Power Consumption Analysis



Efficient Lighting Solutions



HVAC Optimization



Insulation & Weatherproofing



Energy Audits & Assessments



Regular Maintenance & Inspections

Health Care:



Emergency Repair Services



Maintenance Services



Housekeeping & Cleaning Services



Regular Maintenance & Calibration



Medical Gas Pipeline System



Facility Maintenance and Repairs



Security Solutions:

We provide full range of security services from Physical Security, fire safety & parking management. Continuous vigilance of the premises, maintaining the records of the visitors moving & out of the premises is done by our trained guards.





Payroll Management & Staffing Services:

We understand that time is money, so why not free up your resources and maximize your time spent on profit-generating activities? We minimize your headaches by functioning as your external business partner that specializes in handling all payroll administration activities such as Salary Processing i.e. provident funds processing, ESI, bonuses, Gratuity, incentives, medical claims, Bank Account Opening, corporate insurance policies etc.

AURA Facilities Management Pvt. Ltd. also provides wide variety of experienced skilled and semi skilled workforce to work in your manufacturing and administrative locations.

As we take care of our deputed very well, productivity at your site will go only one way, that is, up!

We also undertake personality development and soft skill training.

Pest Management:

AURFAM provide a complete range of pest management solutions through our professional services and quality products. We offer safe and effective treatment for Cockroaches, flies & Mosquitoes, Ants, Silverfish & firebrats, termites, rats, wood borer, bugs, lizards, Pigeons etc.



Specialized Cleaning:

- Carpet Shampooing.
- Marble Polishing & Honning.
- Chair/Sofa Shampooing.
- One time deep cleaning.
- Facade cleaning.



Trusted Facility Services Customized for Your Industry!

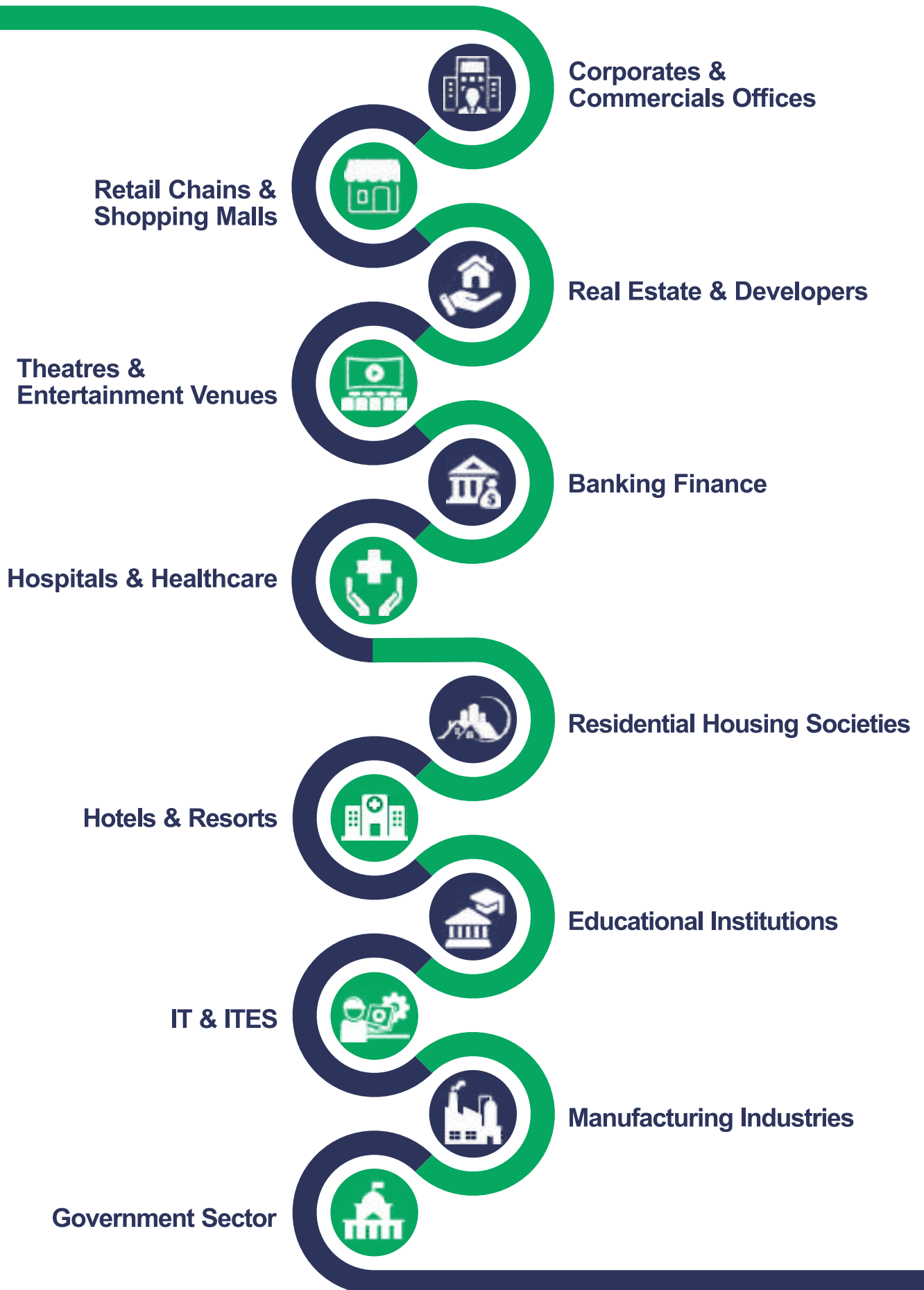

Expanding Our Reach to Serve You Better

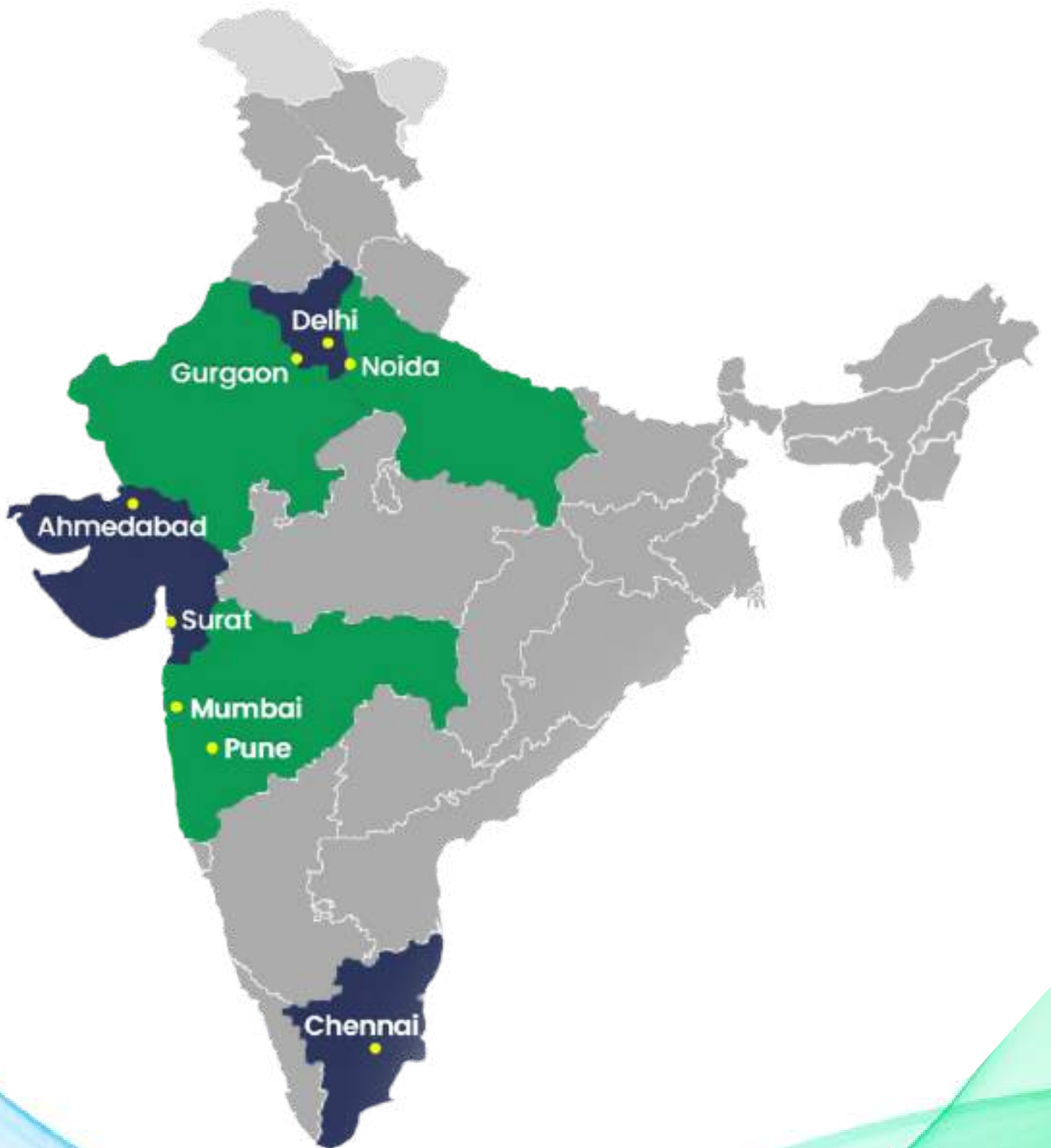

In Associations:

Our continued participation in these areas is designed to keep AURA FM and its people up-to-date with industry, service and legislative news ensuring we are equipped to deliver the best possible service to our clients.



Indian Facility Management Association



Monthly Magazine on Cleanlines & Hygiene



ISO 9001:2001 Quality Management system



ISO 14001:2004 Environmental Management system



Our Satisfied Clients:



FMS Private Limited

Office Address:

B/002, Duplex Heights, Parasrampur
Tower No: 6, Lokhandwala, Near Millat Nagar,
Andheri (W), Mumbai - 400053, India.

 +91-8655661739 +91-9820403068

 info@aurafms.com

 www.aurafacilitiesmanagement.com

Follow Us



**To View Website
Please Scan QR Code**